

# PAPER CRAFT

<http://www.canon.com/c-park/en/>



● View of completed model

## Turkey Sultan Ahmet Camii

Formally known as Sultan Ahmed Camii, this mosque was built by Sultan Ahmed I, over seven years between 1609 and 1616, and is known as one of the world's most beautiful Islamic mosques. Called "cami" in Turkish, the interior walls of the mosque are decorated with around 21,000 beautiful blue and white Iznik ceramic tiles, giving the mosque its more popular name of "Blue Mosque". Some 260 stained glass windows help create a beautifully mystical atmosphere as light streams through them. The mosque is still in use as a place of worship. The main dome is approximately 43 meters high, with a diameter of approximately 23 meters, and is supported by four marble columns, each measuring roughly 5 meters in diameter. The only mosque in the world to feature six minarets, the Blue Mosque is one of Turkey's World Heritage sites.

\* This model was designed for Papercraft and may differ from the original in some respects.



● North west face

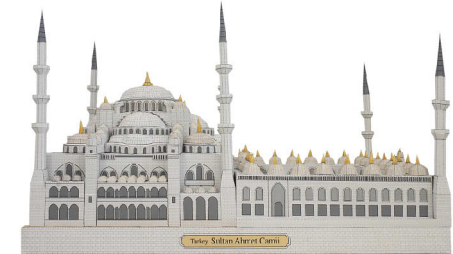

● North east face



● South east face

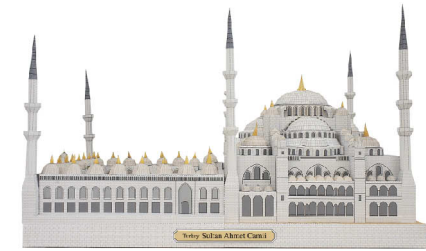

● South west face

■ Parts list (Pattern) : Thirty A4 sheets (No.1 to No.30)

■ No. of Parts : 262

■ Assembly Instructions : Fourteen A4 sheets (No.1 to No.14)

\* Build the model by carefully reading the Assembly Instructions , in the parts sheet page order.

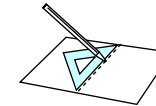

★ Hint: Trace along the folds with a ruler and a used pen (no ink) to get a sharper, easier fold.

### Assembly Instructions

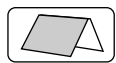

----- **Mountain fold (dotted line)**

- Make a mountain fold.

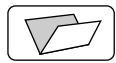

- - - - - **Valley fold (dashed and dotted line)**

- Make a valley fold.

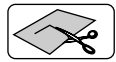

————— **Scissors line (solid line)**

- Cut along the line.



————— **Cut in line (solid line)**

- Cut along the line.

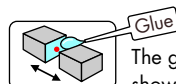

The glue spot (colored dot) shows where to apply the glue.

- **Glue spot (Red dot)**  
Glue parts with the same number together.
- **Glue spot (Green dot)**  
Glue within the same part.
- **Glue spot (Blue dot)**  
Glue to the rear of the other part.

### Tools and materials



- Scissors, set square, glue (We recommend stick glue), pencil, used ballpoint pen, toothpicks, tweezers, (useful for handling small parts)

### Assembly tip



- Before gluing, crease the paper along mountain fold and valley fold lines and make sure rounded sections are nice and stiff.

### Caution



- Glue, scissors and other tools may be dangerous to young children so be sure to keep them out of the reach of young children.

## Before starting.

- Every page of the Assembly Parts section has a number (Sheet 1 to 30) at the bottom of the page, in the center. Follow the assembly in the order of the pages. (\*Assembly Parts are from Sheet 2 to 30)
- There are a total of 262 parts. Each sheet shows the part numbers. Also, on the glue spot of each part, the glue spot number of the corresponding part is printed.
- The numbers ① ② ③, etc., on each parts indicate the order in which they are to be glued.
- Where the same part has multiple connecting points and glue spots where it is to be glued to other parts, colored spots ● ● ● and numbers are given in order to indicate the positions precisely. Follow the illustrations in the Assembly Instructions carefully.

## Sheet No.2

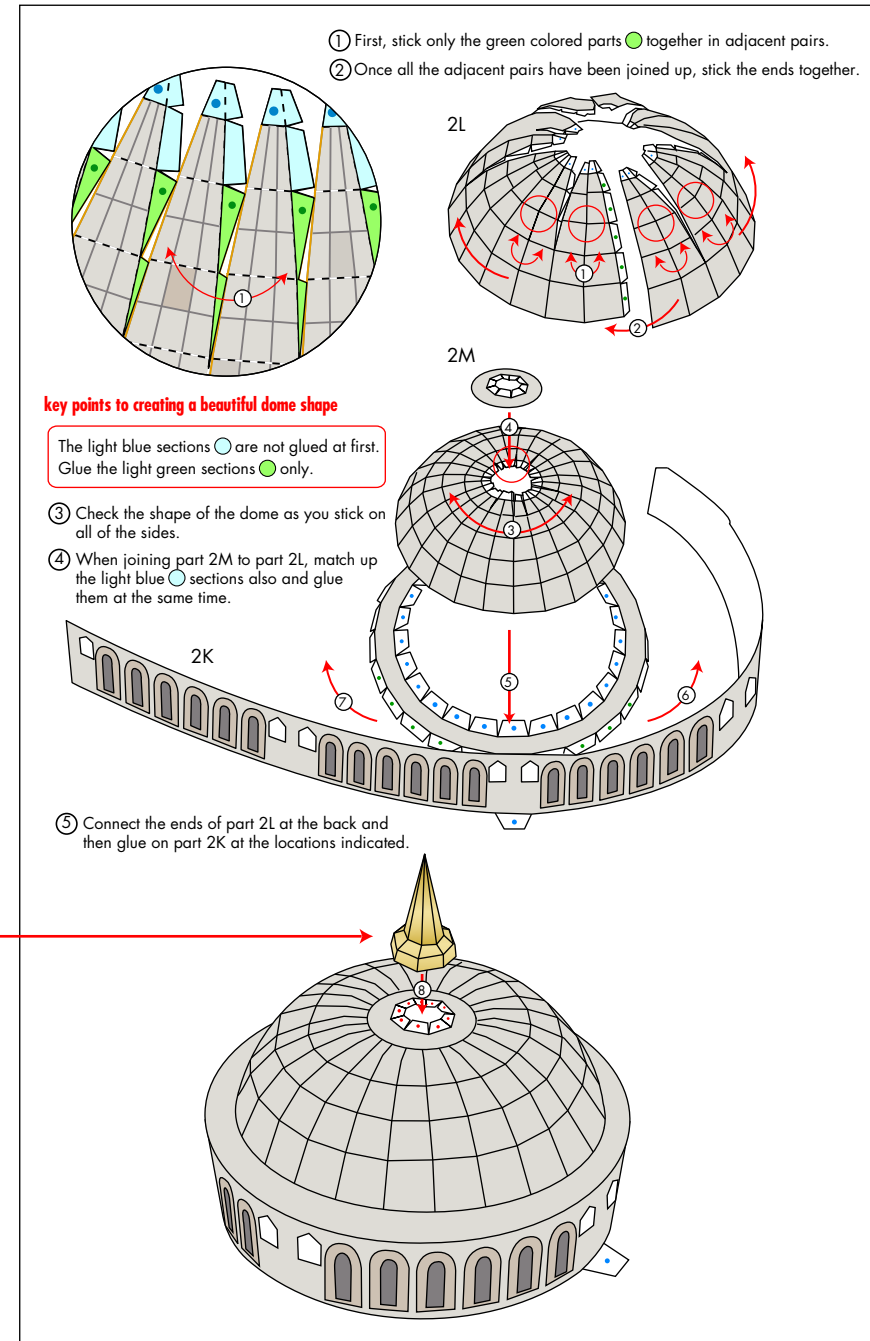
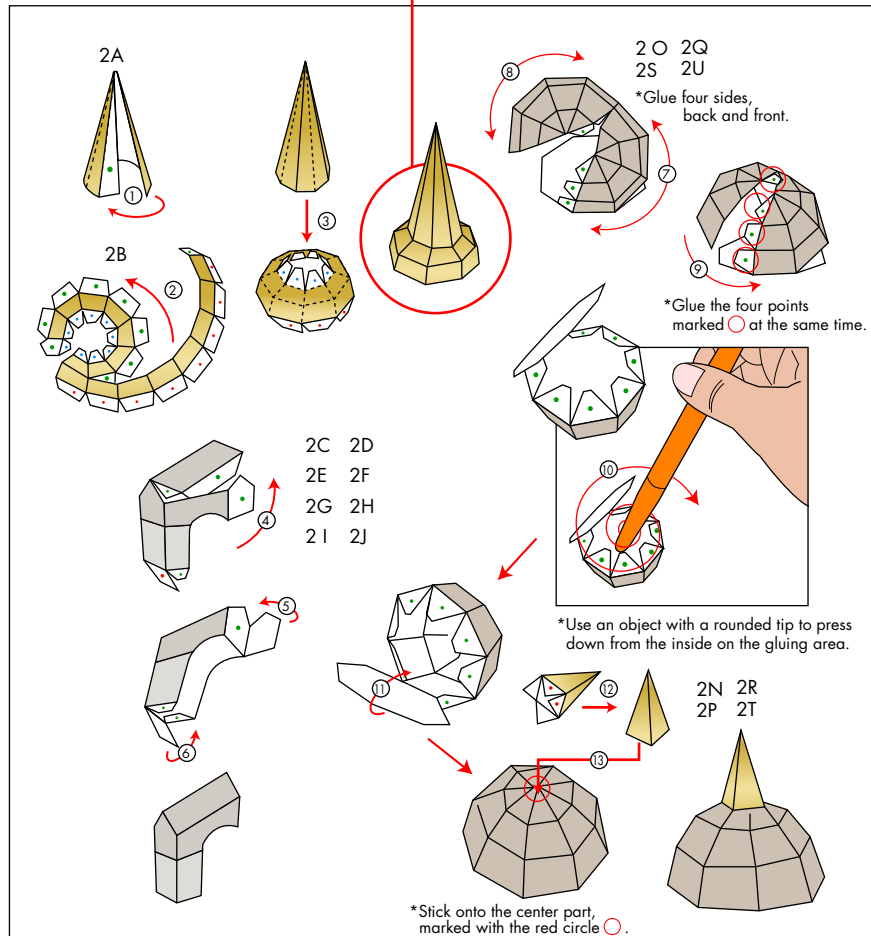

**Sheet No.2**

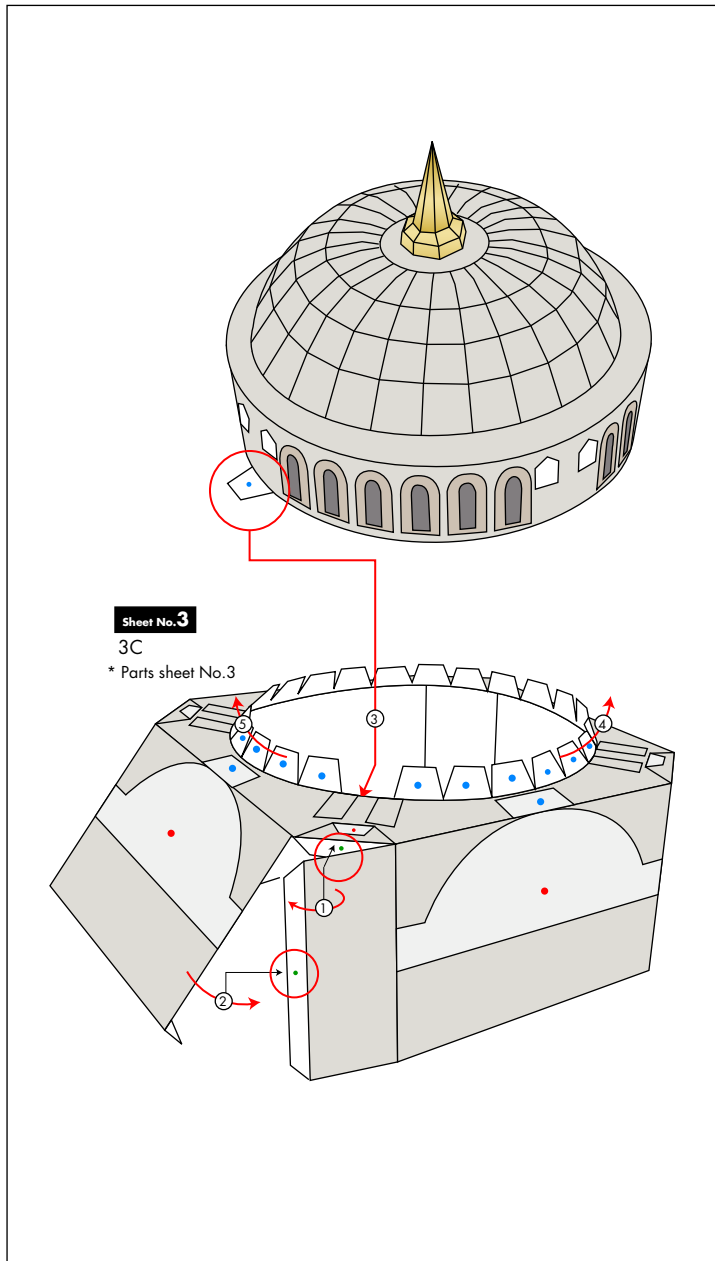

**Sheet No.3**  
3C  
\* Parts sheet No.3

**Sheet No.3 · 4**

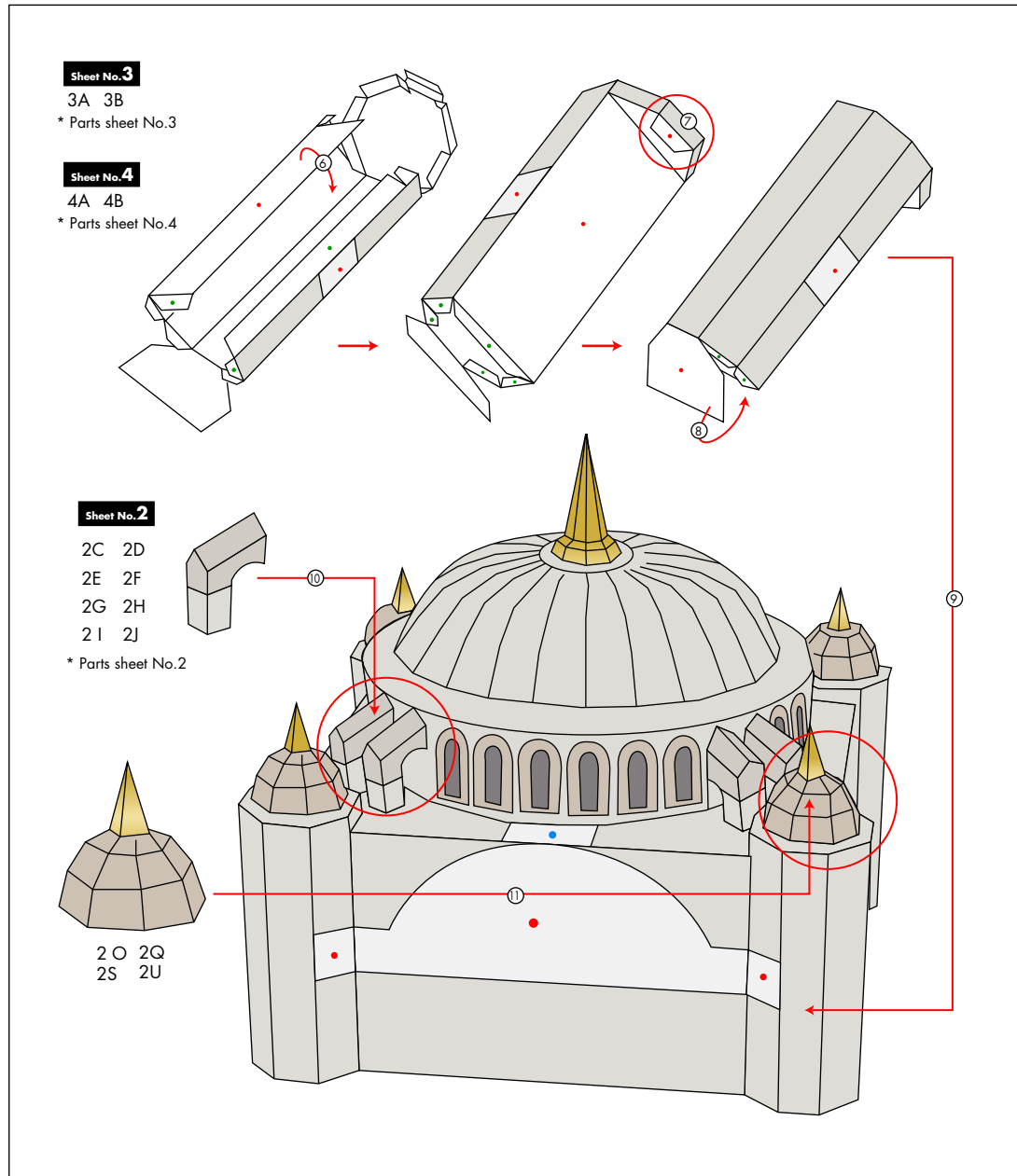

**Sheet No.3**  
3A 3B  
\* Parts sheet No.3

**Sheet No.4**  
4A 4B  
\* Parts sheet No.4

**Sheet No.2**  
2C 2D  
2E 2F  
2G 2H  
2I 2J  
\* Parts sheet No.2

2O 2Q  
2S 2U

**Sheet No.4·5·6·7·8**

**Sheet No.4**

\* Parts sheet No.4

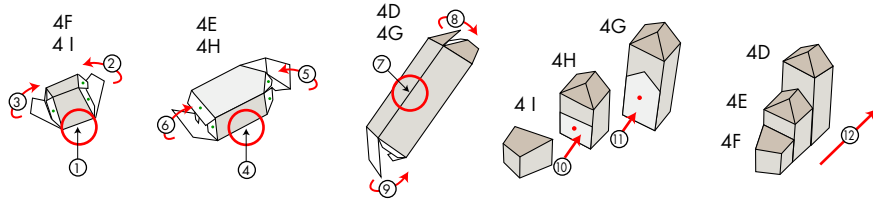

**Sheet No.5**

\* Parts sheet No.5

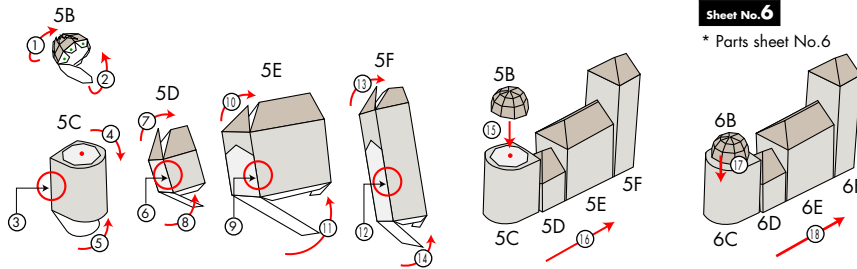

**Sheet No.6**

\* Parts sheet No.6

**Sheet No.6**

\* Parts sheet No.6

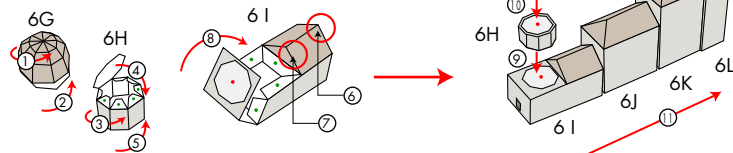

**Sheet No.7**

\* Parts sheet No.7

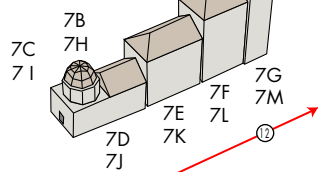

**Sheet No.8**

\* Parts sheet No.8

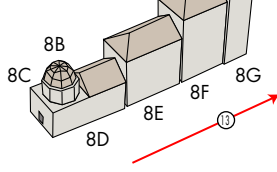

**Sheet No.4·5·6·7**

**Sheet No.6**

\* Parts sheet No.6

**Sheet No.4**

\* Parts sheet No.4

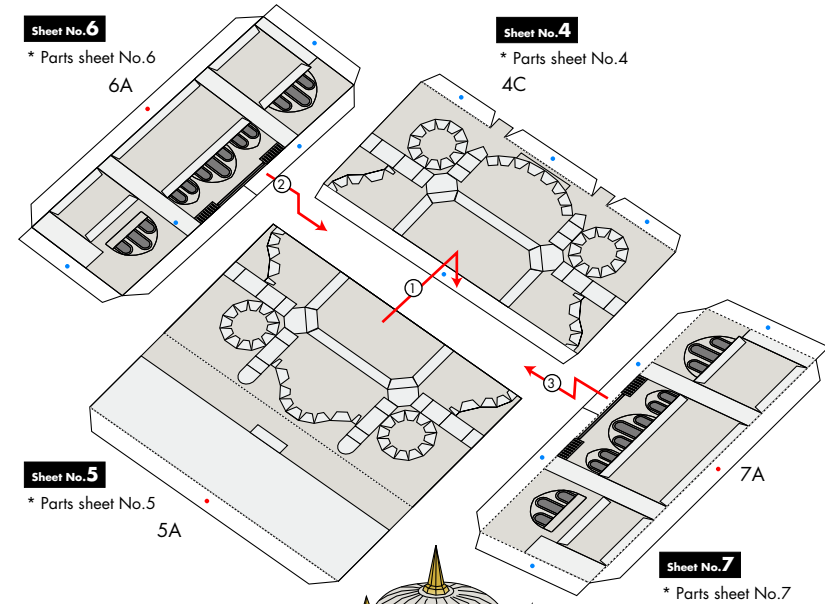

**Sheet No.5**

\* Parts sheet No.5

**Sheet No.7**

\* Parts sheet No.7

**Sheet No. 9 • 10**

Sheet No. 9 Sheet No. 10

\* Parts sheet No. 9, 10

9A  
9H  
10A

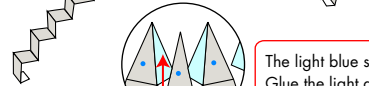

The light blue sections are not glued at first.  
Glue the light green sections only.

9C  
9J  
10C



9F  
9M  
10F

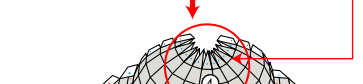
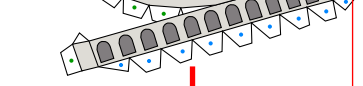
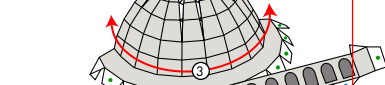

9B  
9I  
10B

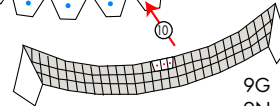
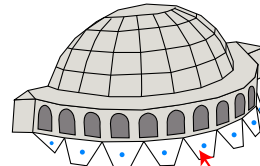
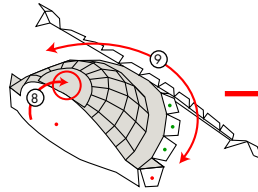
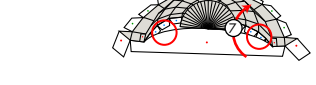

9G  
9N  
10G

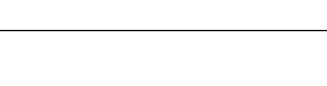
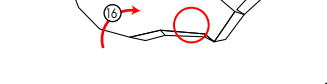
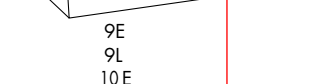
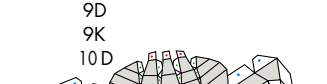

**Sheet No. 10**

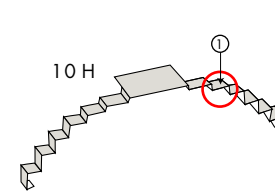

10H

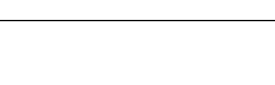
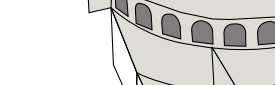
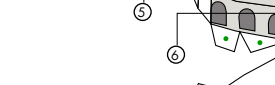
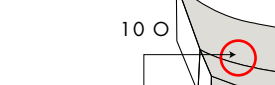
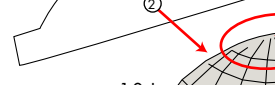
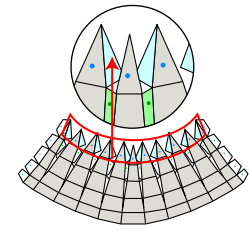

The light blue sections are not glued at first.  
Glue the light green sections only.

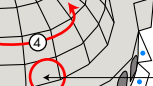
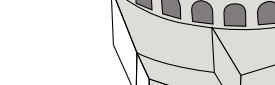
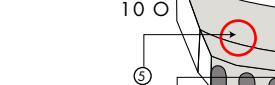

10J

10N

10L

10M

10O

10K

10P

10Q

10R

10S

10T

10U

10V

10W

10X

10Y

10Z

10AA

10AB

10AC

10AD

10AE

10AF

10AG

10AH

10AI

10AJ

10AK

10AL

10AM

10AN

10AO

10AP

10AQ

10AR

10AS

**Sheet No. 8 · 11**

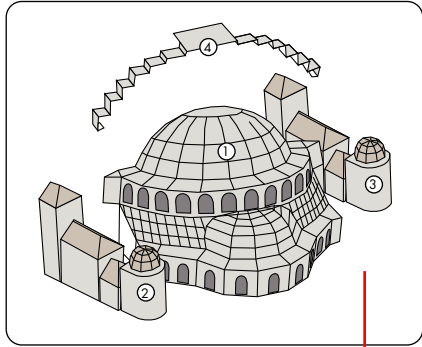

**Sheet No. 11**  
\* Parts sheet No.11

11B 11E  
11H 11K

11A 11D  
11G 11J

11C 11F 11I 11L

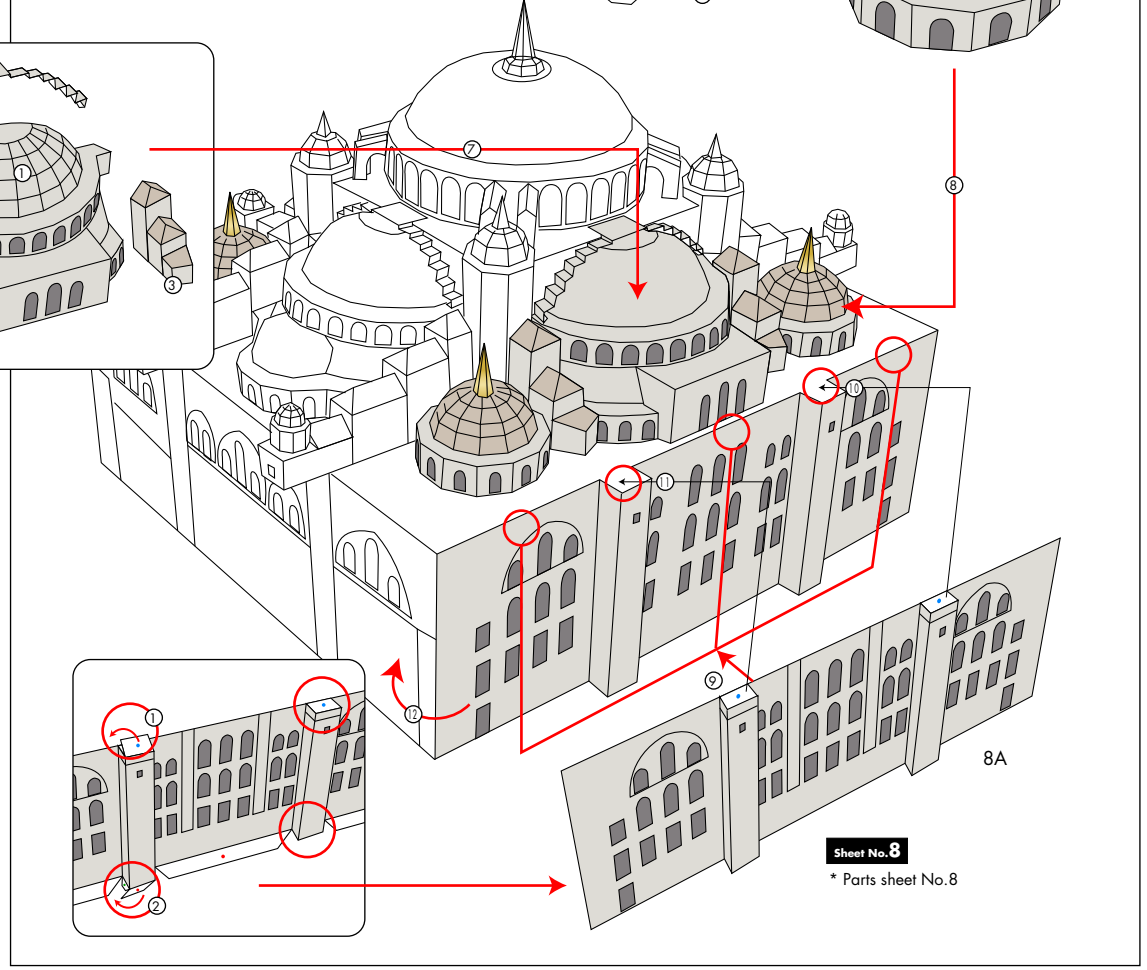
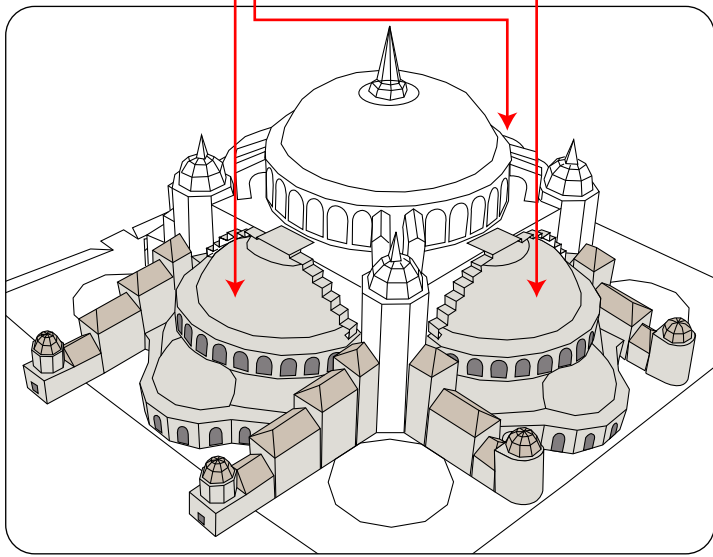
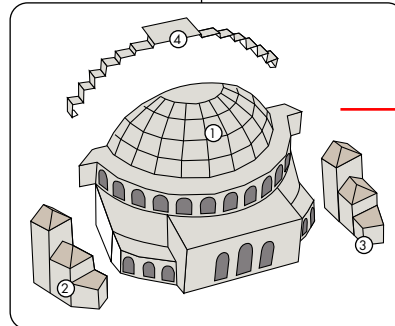
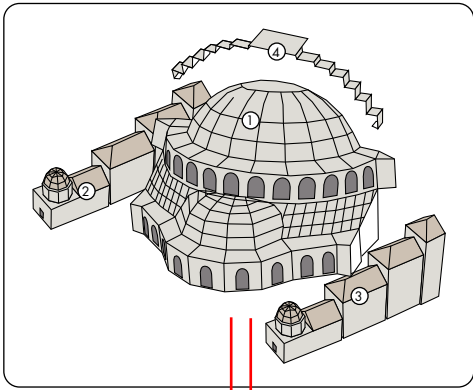
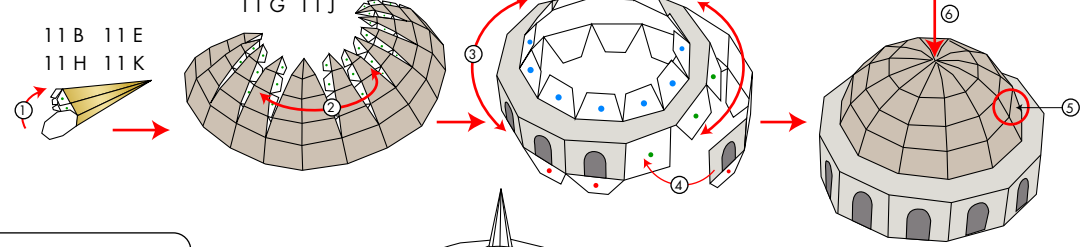

**Sheet No. 8**  
\* Parts sheet No.8

8A

**Sheet No. 12 · 13 · 14 · 15 · 16**

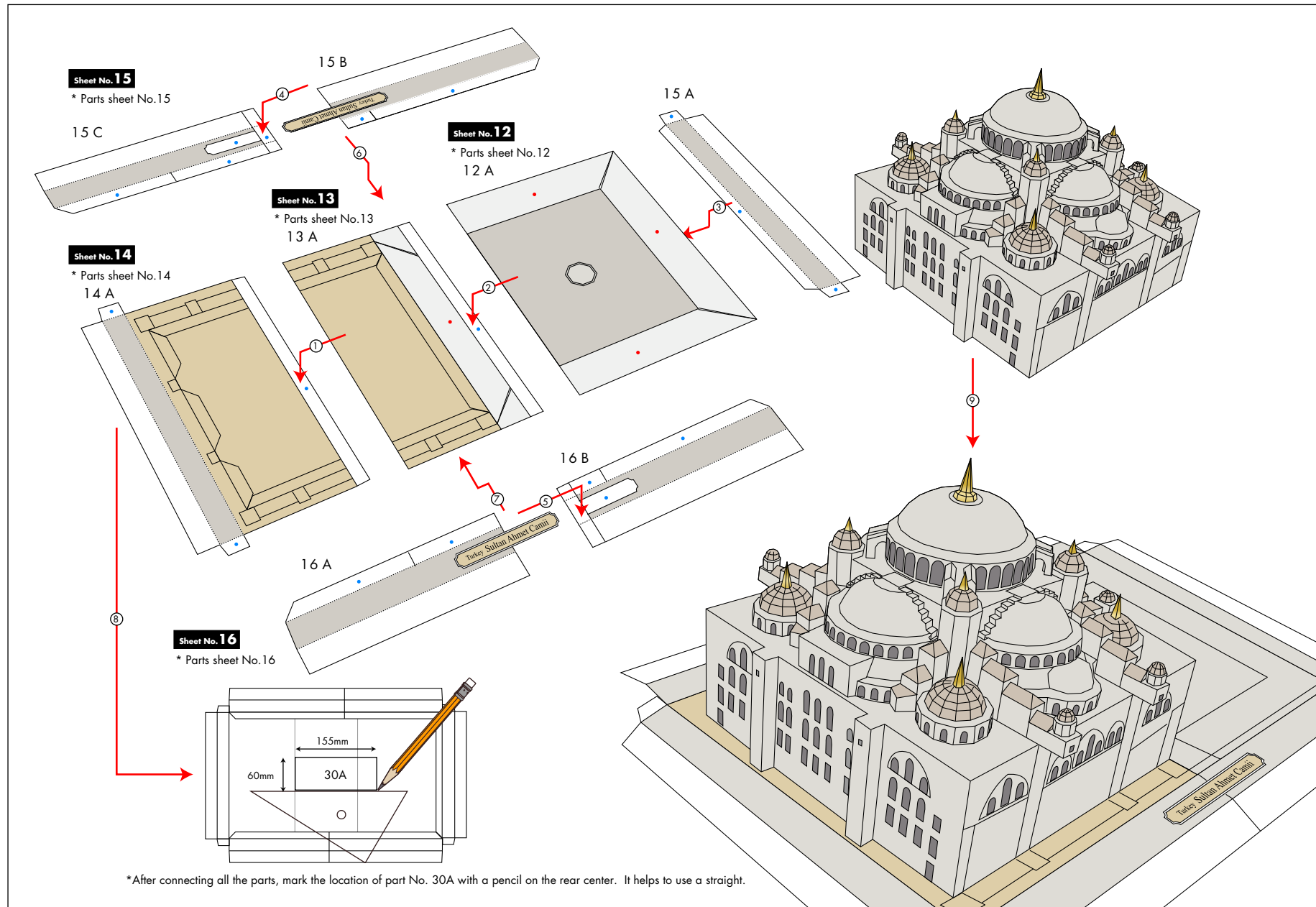

Sheet No. **17 · 18**

**17 A**  
**18 A**

**17 B**  
**18 B**

**17 C**  
**18 C**

**17 D**  
**18 D**

**17 E**  
**18 E**

**17 F**  
**18 F**

**17 G**  
**18 G**

**17 H**  
**18 H**

**17 I**  
**18 I**

**17 J**  
**18 J**

**17 K**  
**18 K**

**17 L**  
**18 L**

**17 M**  
**18 M**

**17 N**  
**18 N**

**1** \*Glue four sides, back and front.

**2**

**3** \*Glue the four points marked ○ at the same time.

**4** \*Use an object with a rounded tip to press down from the inside on the gluing area.

**5**

**6**

**7**

**8**

**9**

**10**

**11**

**12**

**13**

**14**

**15**

Turkey Sultan Ahmet



**Sheet No. 19·20·21**

**Sheet No. 19**

\* Parts sheet No.19

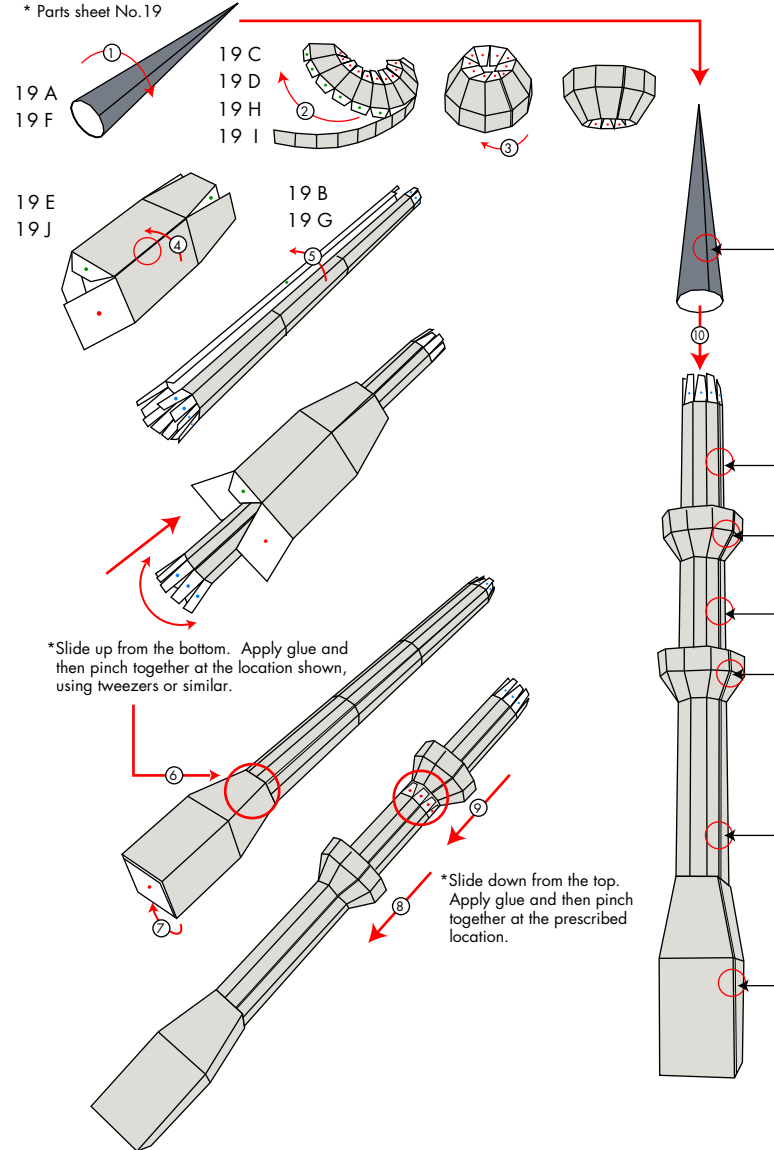

\*Slide up from the bottom. Apply glue and then pinch together at the location shown, using tweezers or similar.

\*Slide down from the top. Apply glue and then pinch together at the prescribed location.

\*Line up the connection locations of the parts to give you a nicer finish.

**Sheet No. 20**

\* Parts sheet No.20

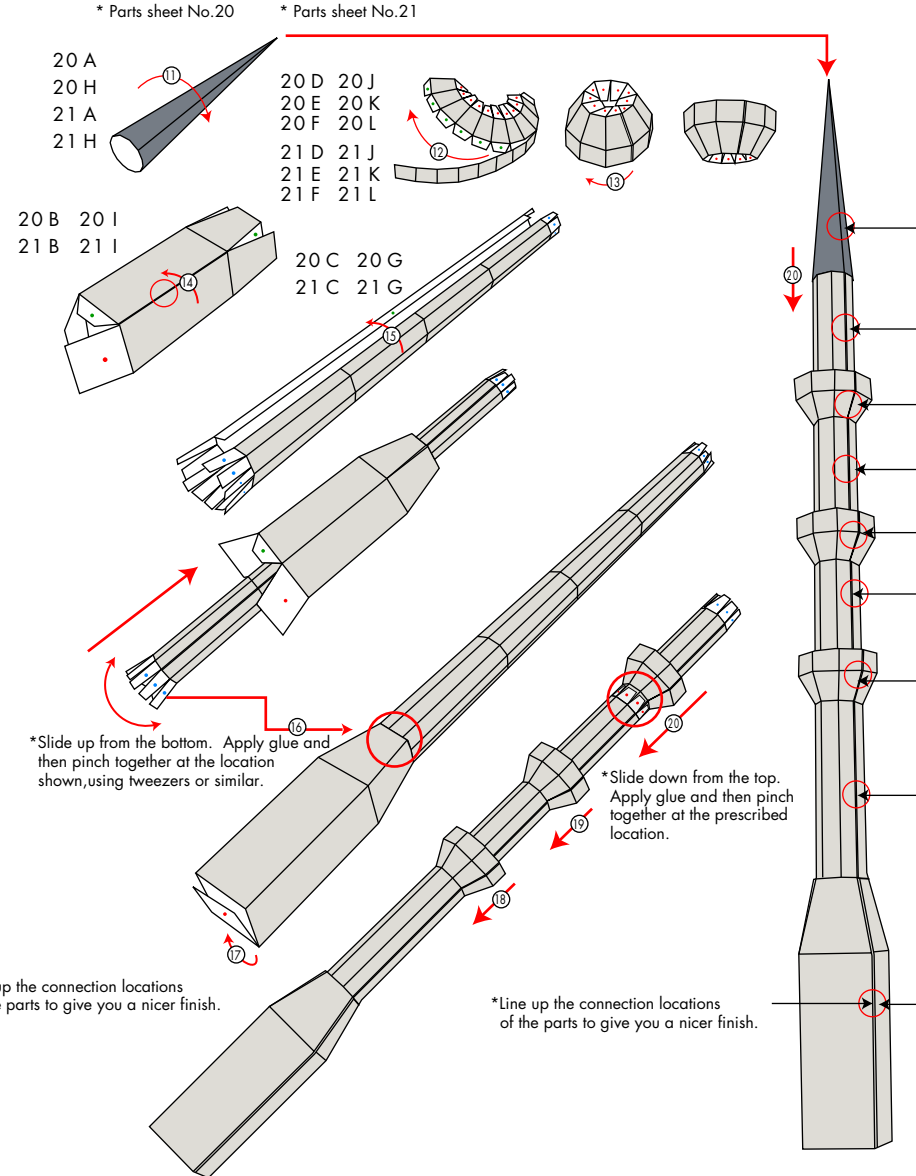

\*Slide up from the bottom. Apply glue and then pinch together at the location shown, using tweezers or similar.

\*Slide down from the top. Apply glue and then pinch together at the prescribed location.

\*Line up the connection locations of the parts to give you a nicer finish.

**Sheet No. 21**

\* Parts sheet No.21

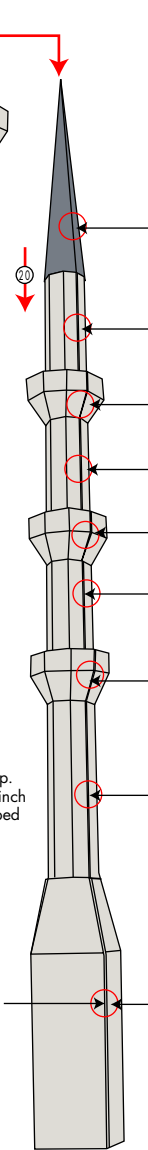

**Sheet No. 22 · 23 · 24 · 28**

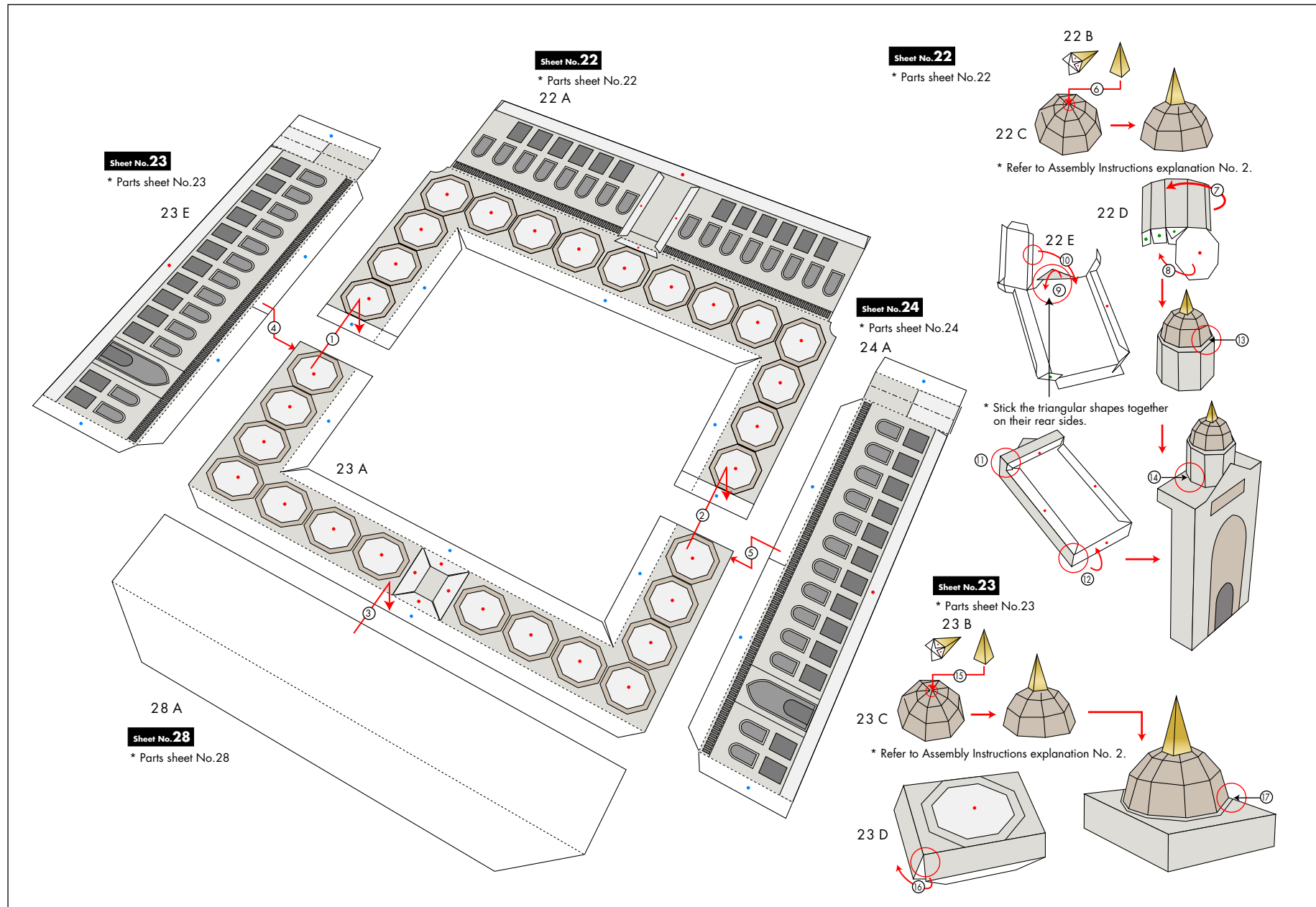

**Sheet No. 24 · 25**

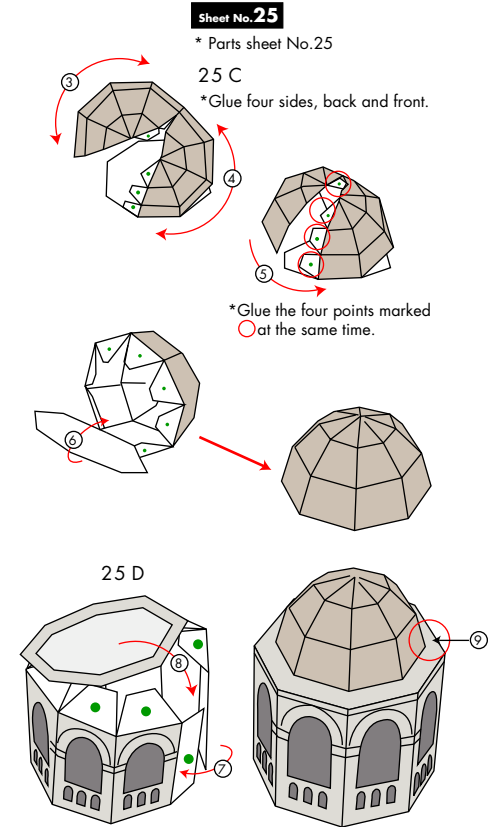
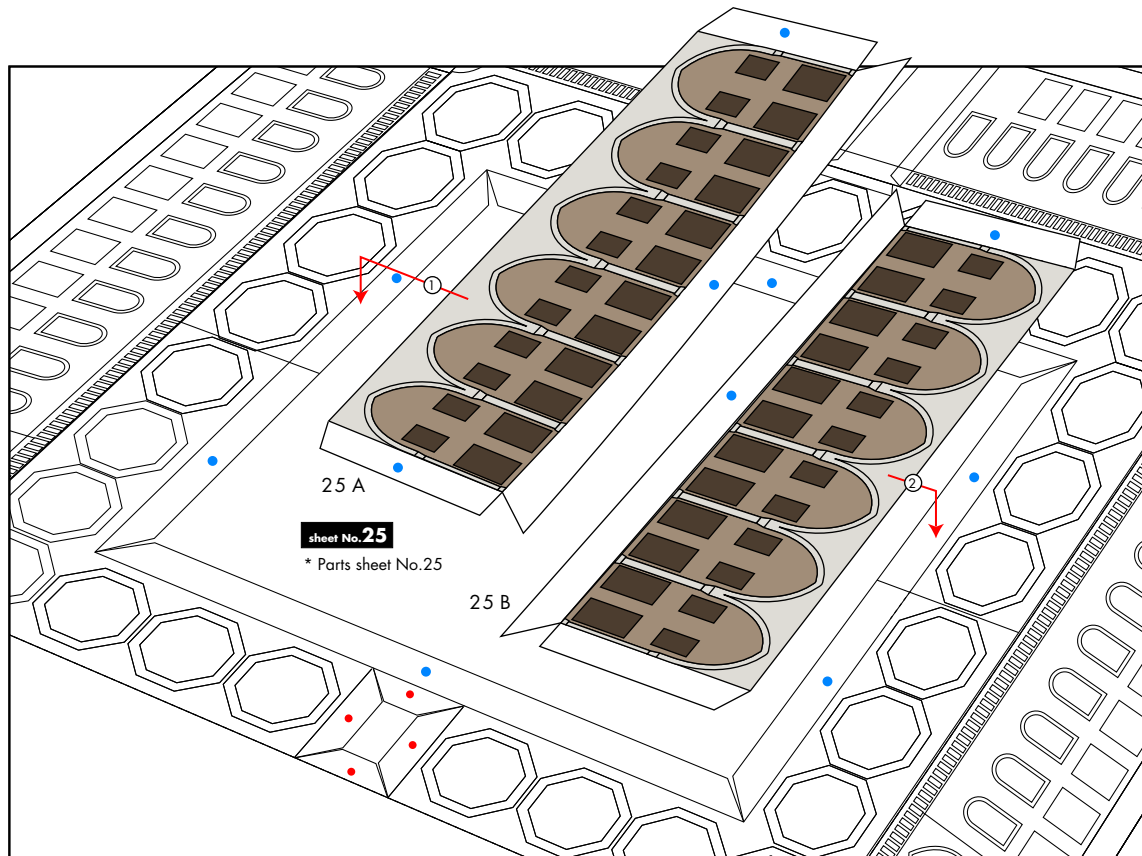

**Sheet No. 24** 24 C 24 E 24 G 24 I 24 K  
\* Parts sheet No. 24 24 M 24 O 24 Q 24 S 24 U

**Sheet No. 25** 25 F 25 H 25 J 25 L 25 N  
\* Parts sheet No. 25

**Sheet No. 24** 24 B 24 D 24 F 24 H 24 J  
\* Parts sheet No. 24 24 L 24 N 24 P 24 R 24 T

**Sheet No. 25** 25 E 25 G 25 I 25 K 25 M  
\* Parts sheet No. 25

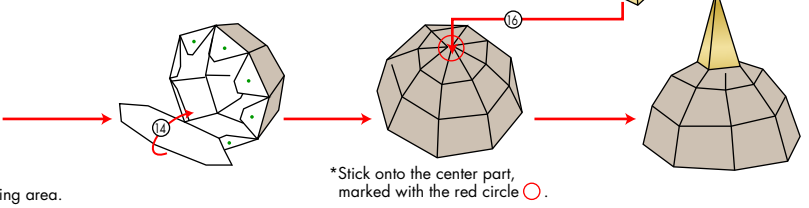
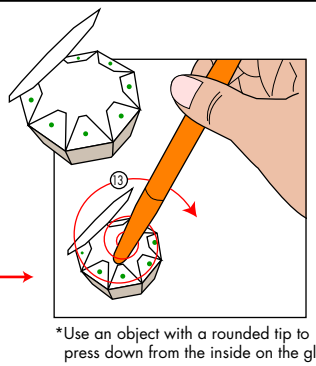
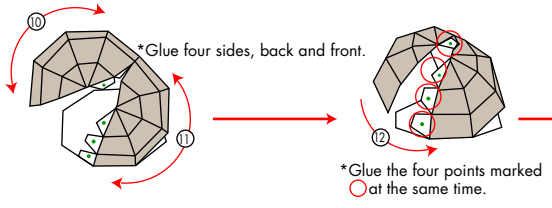

**Sheet No. 26 · 27**

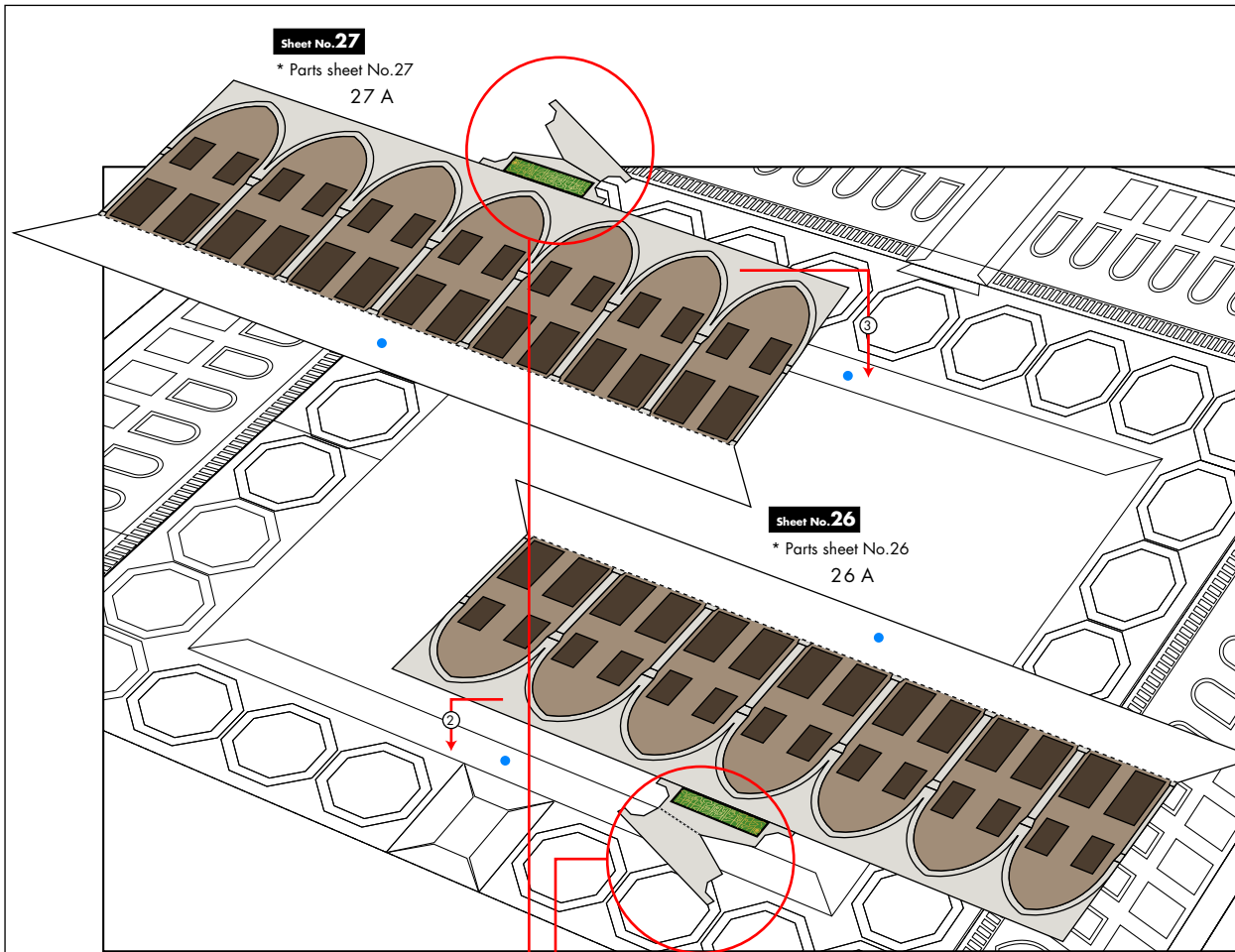

\* Refer to Assembly Instructions Page 13 for details on the connection of 26A and 27A.

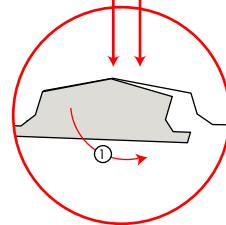

\* Line up the shapes and stick them together on their rear sides.

**Sheet No. 26** 26 C 26 E 26 G 26 I 26 K  
\* Parts sheet No. 26 26 M 26 O

**Sheet No. 27** 27 C 27 E 27 G 27 I 27 K  
\* Parts sheet No. 27 27 M 27 O

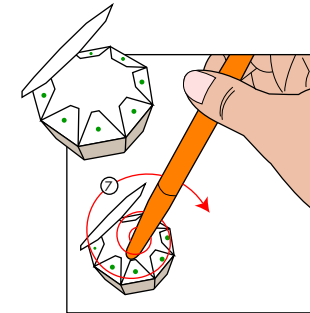
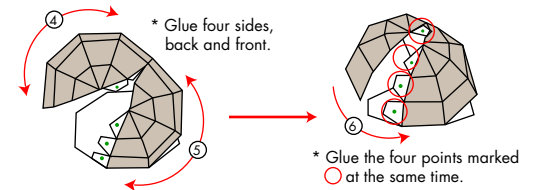

\* Use an object with a rounded tip to press down from the inside on the gluing area.

**Sheet No. 26** 26 B 26 D 26 F 26 H 26 J  
\* Parts sheet No. 26 26 L 26 N

**Sheet No. 27** 27 B 27 D 27 F 27 H 27 J  
\* Parts sheet No. 27 27 L 27 N

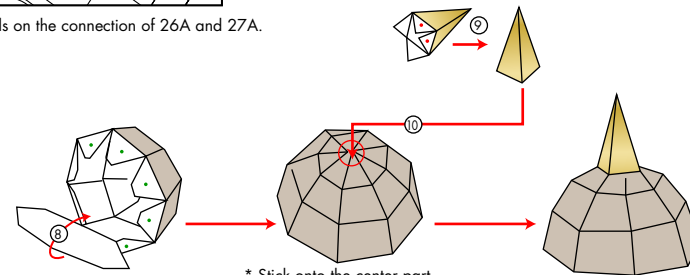

\* Stick onto the center part, marked with the red circle.

**Sheet No.28 · 29**

Sheet No.28

\* Parts sheet No.28

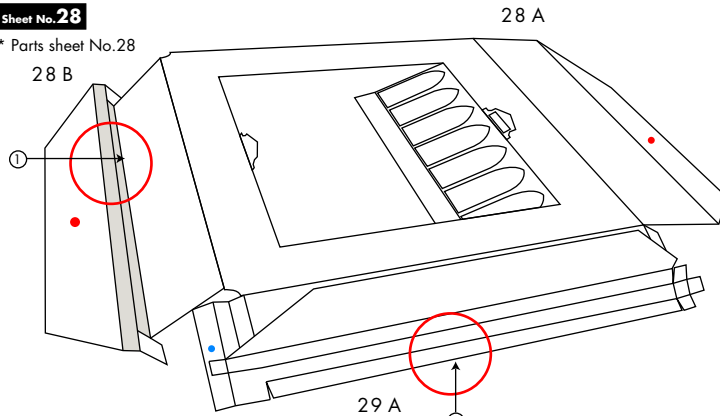

Sheet No.29

\* Parts sheet No.29

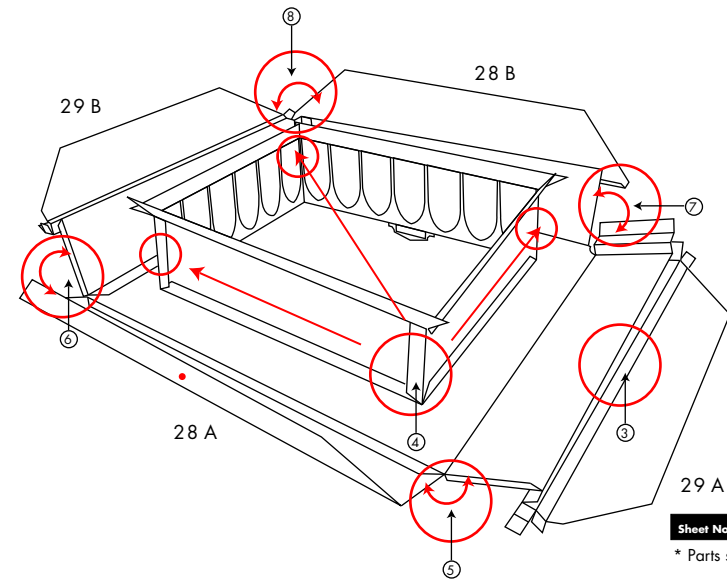

Sheet No.29

\* Parts sheet No.29

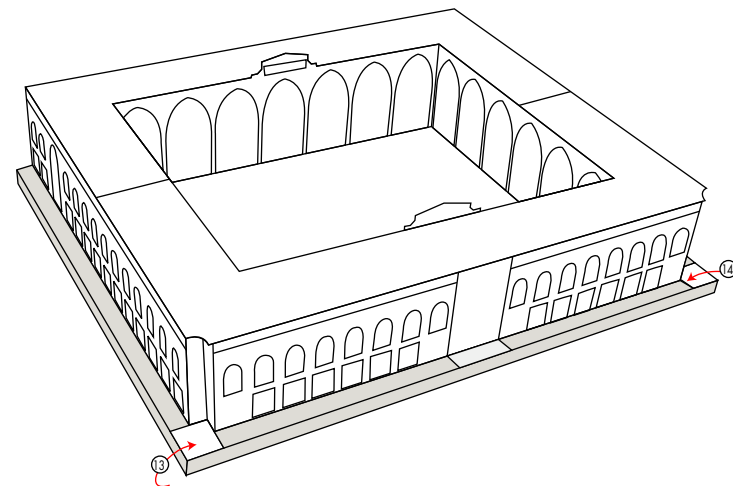
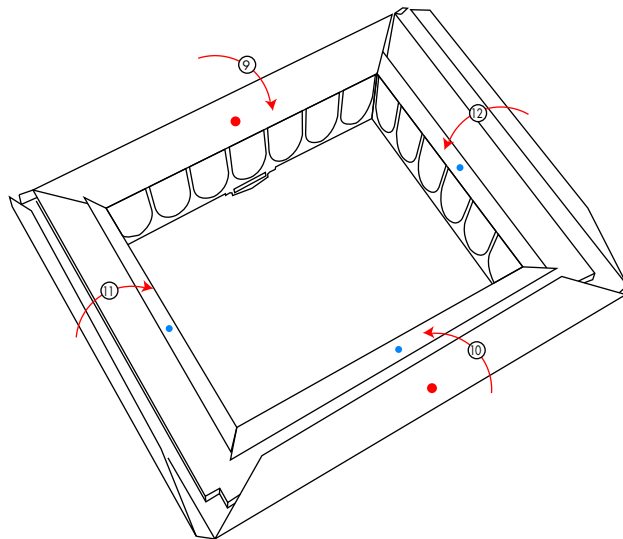

Sheet No. 30

